

Sentinel Door Closers

Series 50 Includes a parallel arm bracket

Spray Finish: Aluminum or Dark Bronze.

| Model | Size | List Price |
|-------------------|---|------------|
| 52BC-P | 2 | \$90 |
| 53BC-P | 3 | \$90 |
| 54BC-P | 4 | \$90 |
| 55BC-P | 5 | \$99 |
| 51BFBC Adjustable |  1-4 | \$102 |
| 51BC Adjustable | 3-6 | \$102 |

All 50 Series closers have aluminum alloy bodies with high compression steel springs for doors opening 180° maximum. The closers have two non-critical thermostatic valves to separately control sweep and latch speeds and provide constant dosing speeds. All S51BF closers have adjustable spring power from sizes 1 thru 4. All S51BF comply with 5 lb. interior and 8 1/2 lb. exterior barrier-free opening force restrictions. All S52 thru S55 closers have fixed spring sizes. The closers feature body and arm assemblies that are corrosion resistant and can be installed in regular, top jamb and parallel arm applications. All S50 Series closers are capable of track installation. Min door rail for closer 2-3/8" Width of closer is 9-11/16"; Projection is 2-7/8"

Selection Chart:

| Door Width | 26" to 30" | 30" to 36" | 36" to 42" |
|------------|-------------|-------------|------------|
| Exterior | 53BC/51BFBC | 54BC/51BFBC | 55BC/51BC |
| Interior | 52BC/51BFBC | 53BC/51BFBC | 54BC/51BC |

Cross Reference: Norton 9000; LCN 1070; Dorma 642-645; Corbin DC2600; Sargent 1100; Yale 2300

ADDITIONS:

| Item | | List |
|-----------------------|-----|------|
| Hold Open | Add | \$26 |
| Drop Plates | Add | \$22 |
| Backplate | Add | \$40 |
| Angle Bracket | Add | \$17 |
| Thru-Bolts (set of 4) | Add | \$7 |

WARRANTY:

Each closer is backed by a 25-year limited warranty when used with ball bearing hinges.

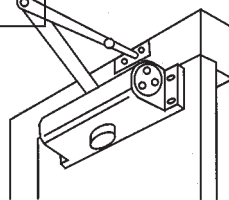

Standard Installation

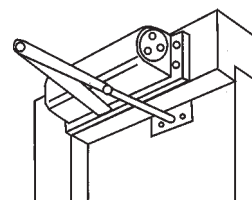

Top Jamb Installation

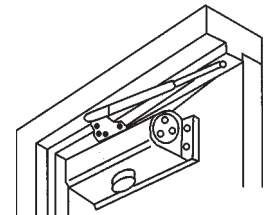

Parallel Arm Installation

Optional Accessories

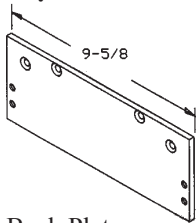

Back Plate

For top jamb mount when overhead ceiling clearance is less than 2-1/4" or for regular mount to clear a mortised stop/holder.

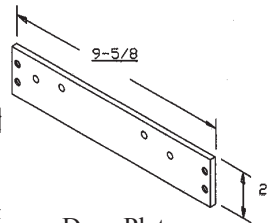

Drop Plate

For top jamb mount when overhead ceiling clearance is less than 1-7/8". Permits parallel arm installation with min. top door rail of 2-1/2" for non-hold open, 2-5/8" for hold open.

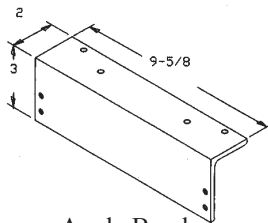

Angle Bracket

For installation where parallel arm and top jamb applications are not practical due to low overhead ceiling clearance or narrow frame. This bracket can also be used to provide clearance for a surface-applied stop/holder.

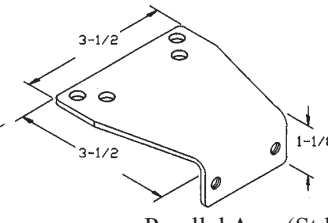

Parallel Arm (Std)

For Non-Hold Open and hold open 30-150° arm applications.

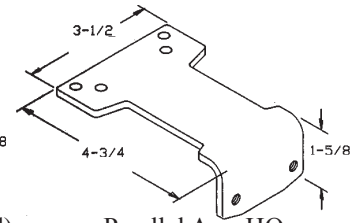

Parallel Arm HO

For Hold Open 90-180° parallel arm applications.

Series SN 123

Residential Automatic Door Closer

| | List Price | Finishes |
|---------|------------|-----------------------------|
| SN123HO | \$55 | Silver, Black, White, Brown |

Specifications:

| Max Dr Width | Max Dr Weight | Max Open Angle Dr Mount | Max Angle at which Hold Open Engages |
|--------------|---------------|-------------------------|--------------------------------------|
| 42" | 150lb | 169° | 110° |

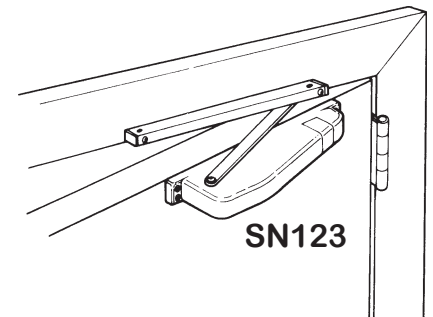

SN123

SERIES SN123 SPECIFICATIONS & FEATURES: 2-step speed adjustment closes any door softly, latches securely every time. Reversible for right or left hand openings; outswing or inswing doors. Low-profile design with exclusive slide-track arm fits flush; does not protrude into room. No springs to wear out; no oil to leak. SN123/HO is ideal for all interior and exterior doors. Two year warranty.